

Non-contact liquid level sensor instruction manual

(Intelligent externally attached liquid level detection products)

XKC-Y25-V

table of Contents

1st. Overview	2
2nd.Product Features	2
3rd.Product Applications	2
4th.Product parameter	3
5th.product selection.....	3
6th. Clearance requirements.....	3
7th. Installation method	4
8th.Application environment.....	9
9th. output principle and recommended wiring method	9
10th. Sensitivity adjustment	10
11th. Product size and physical map.....	11
12th.Other matters needing attention.....	12
13th.Troubleshooting:.....	12
14th.Product warranty terms and instructions	13
15th. Manual version.....	14

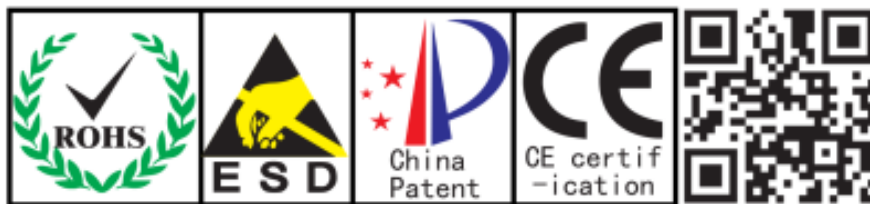

1st. Overview

The intelligent non-contact liquid level sensor (hereinafter referred to as the liquid level sensor) adopts advanced signal processing technology and high-speed signal processing chip, which breaks through the influence of container wall thickness and realizes a true non-contact type of liquid level height in a closed container Detection. The liquid level sensor (probe) is installed on the upper and lower sides of the outer wall of the container to be measured (the high and low levels of the liquid level). The non-metallic container does not need to be opened, and the installation is simple and does not affect production. It can detect the liquid level of various liquid toxic substances, strong acids, strong alkalis and various liquids in high-pressure airtight containers. The liquid level sensor has no special requirements for the material of the liquid medium and non-metallic container, and can be widely used. XKC-Y25-XXX series products are specially developed for non-metallic container liquid level detection. This series of liquid level sensors are divided into four signal output control methods, namely high and low level output interface, NPN output interface, PNP output interface, RS485 Output interface; the four signal output modes correspond to the following four models:

Serial number	type number	signal interface
1	XKC-Y25-V	High and low level output interface
2	XKC-Y25-NPN	NPN output interface
3	XKC-Y25-PNP	PNP output interface
4	XKC-Y25-RS485	RS485 output interface

2nd.Product Features

1. XKC-Y25-XXX non-contact liquid level sensor is suitable for non-metallic containers. The product detects the liquid through the detection signal through the non-metallic container and the outer wall of the pipeline, without direct contact with the liquid, and will not be subject to strong acid, Corrosion damage caused by corrosive liquids such as strong alkalis is not affected by scale or other debris, and it can be completed to detect whether there is liquid inside the container or pipeline.
2. It can support high and low level output, NPN, PNP signal output (please refer to the manufacturer's instructions when selecting the model).
3. The detection liquid level is accurate and stable, and cold, hot and boiling liquids can be detected.
4. Pure electronic circuit structure, non-mechanical working mode, stable performance and long lasting service life.
5. High stability, high sensitivity, strong anti-interference ability, free from external electromagnetic interference, special treatment for power frequency interference and common mode interference, to be compatible with all 5-24V power adapters on the market.
6. It has a wide range of application and strong sensing capability. It can penetrate and detect the liquid level in various non-metallic containers, such as plastic, glass, ceramics and other containers. The sensing distance (container wall thickness) can reach 20mm; liquid, powder, Particles can be detected.
7. Open collector output mode, wide voltage range (5-24V), suitable for connecting various circuits and product applications.

3rd.Product Applications

The intelligent non-contact liquid level sensor uses the inductive capacitance of water to detect the presence of liquid. When there is no liquid close to the sensor, the sensor has a certain static capacitance to the ground due to the presence of distributed capacitance on the sensor. When the liquid level is slow When the sensor is slowly raised, the parasitic capacitance of the liquid will be coupled to the static capacitance of the sensor, making the capacitance value of the

sensor larger. The changed capacitance signal is then input to the control IC for signal conversion, and the changed capacitance is converted into a circuit signal. The MCU calculates and judges the degree of the change in the analog quantity. When the change exceeds a certain threshold, it is considered that the liquid level has reached the sensing point.

4th. Product parameter

Project name	Parameters
Product model	XKC-Y25-V
Supply voltage (Vin)	(DC 5V-24V)
Output mode	High and low level
Power ripple requirements	≤200 mV
electric current	≤5mA
Response time	500mS
Working temperature	-20~105°C
humidity	5%~100%
Induction thickness (Sensitivity) range	≤20mm (Container wall thickness)
Liquid level accuracy	±1.5mm
Line length	500MM (±10MM) (Bulk can be customized)
Terminal sequence	Brown (power supply positive), yellow (signal output) Blue (power negative), black (COM terminal)
Material	PC V0 Fireproof material
Waterproof performance	IP67
Safety standard certification	CE
Environmental protection certification	ROHS-2.0

5th. product selection

High and low level ————— Model: XKC-Y25-V (DC 5V-24V)

6th. Clearance requirements

Requirements for the clearance between the contact surface of the sensor (or probe) and the outer wall of the container. The contact surface of the sensor (or probe) and the outer wall of the container should be tightly pasted with AB or other solid-resistant glue. If there are special requirements, the gap should be less than 0.5mm, preferably no gap, otherwise it may affect the measurement accuracy.

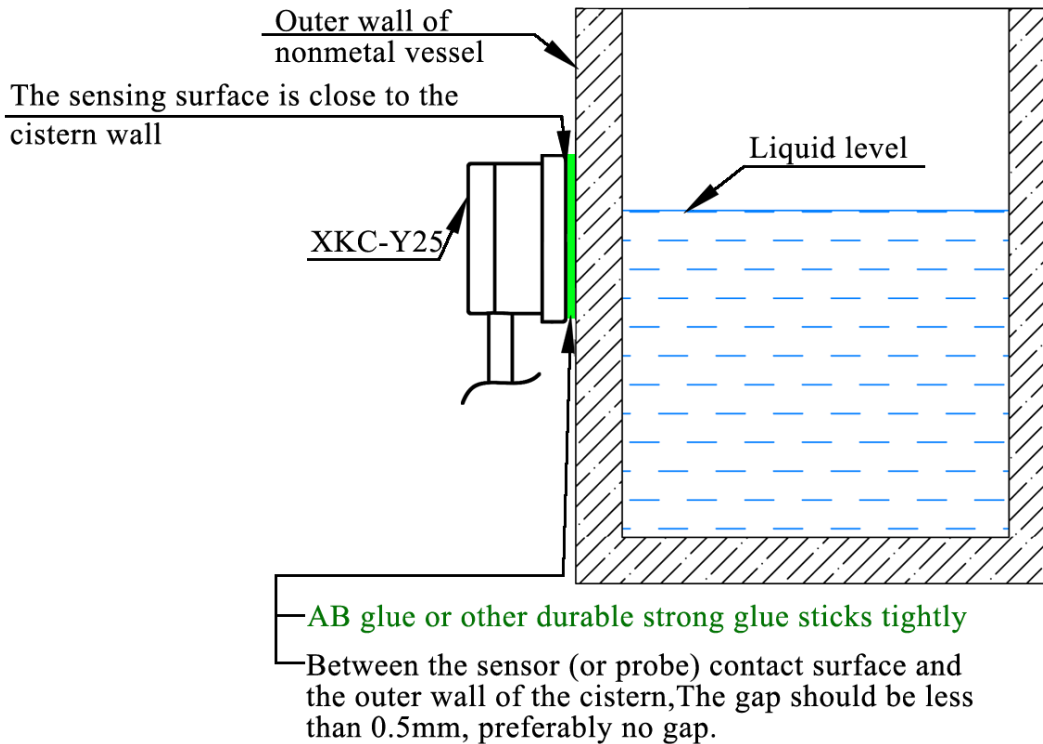

7th. Installation method

The following is the installation method of XKC-Y25 series products, the installation method of other models is the same.

(1) Requirements and installation methods of the tested container The tested containers are divided into 3 categories according to their materials: The first category: insulating material container

Containers made of non-metallic materials with flat surface, uniform thickness, compact materials, and good insulation properties; such as glass, plastic, non-absorbent ceramics, acrylic, rubber and other materials or their composite materials.

installation method:

1. If the container wall where the measuring probe is installed is of multi-layer material, the layers should be in close contact with each other without bubbles or gas interlayers. The inner and outer surfaces of the container wall should be flat.
2. Wall thickness: 0-20mm
3. Tank type: spherical tank, horizontal tank, vertical tank, etc.
4. The installation method of this kind of material container is shown in Figure 1; The probe can be pasted and fixed with glue or fixed on the outer wall of the container with a non-metal bracket.

Try to avoid metal and other parts where the probe is installed, so as not to affect the detection.

The position where the probe is installed should try to avoid the position where the liquid flows.

There should be no silt or other debris inside the container facing the low-level probe, so as not to affect the detection;

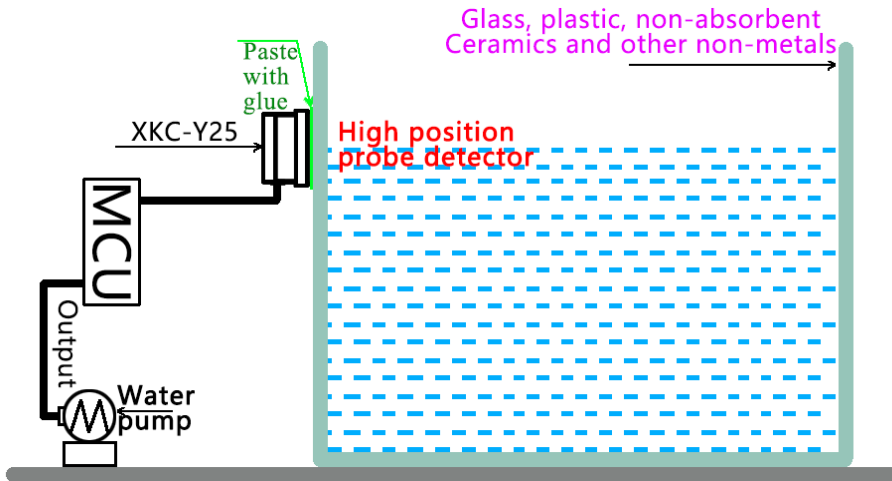

Figure 1-1 The top image of a non-metallic container of a probe installation diagram

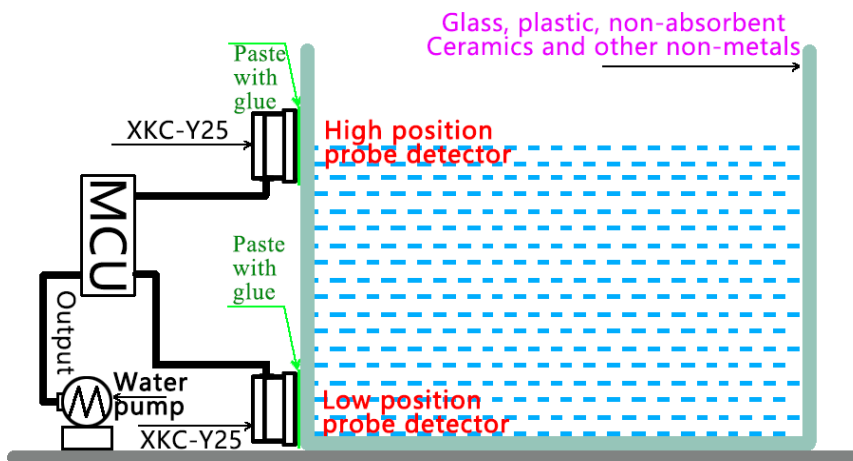

Figure 1-2 The above diagram of the installation of two probes in a non-metallic container

The second category: metal conductive material container

Containers made of metal or other conductive materials; such as stainless steel, copper, aluminum alloy or materials with electroplated metal layers on the surface. Because capacitive sensors are sensitive to all conductive objects, this type of container cannot be directly attached to the outer wall of the container; therefore, for containers of this type of material, holes need to be made on the side of the container. The installation method is as follows.

installation method

1. Prepare two rubber plugs and the necessary tools for opening threaded holes;
2. Two threaded holes are opened in the high position and the low position respectively, and the hole diameter matches the size of the rubber plug;
3. Put a rubber plug on the threaded hole and tighten it to check for water leakage, and add glue to seal if necessary;
4. Paste the sensor on the rubber plug with glue and fix it with the bracket. After the glue has solidified, remove the bracket. The installation of the metal container is shown in Figure 2.

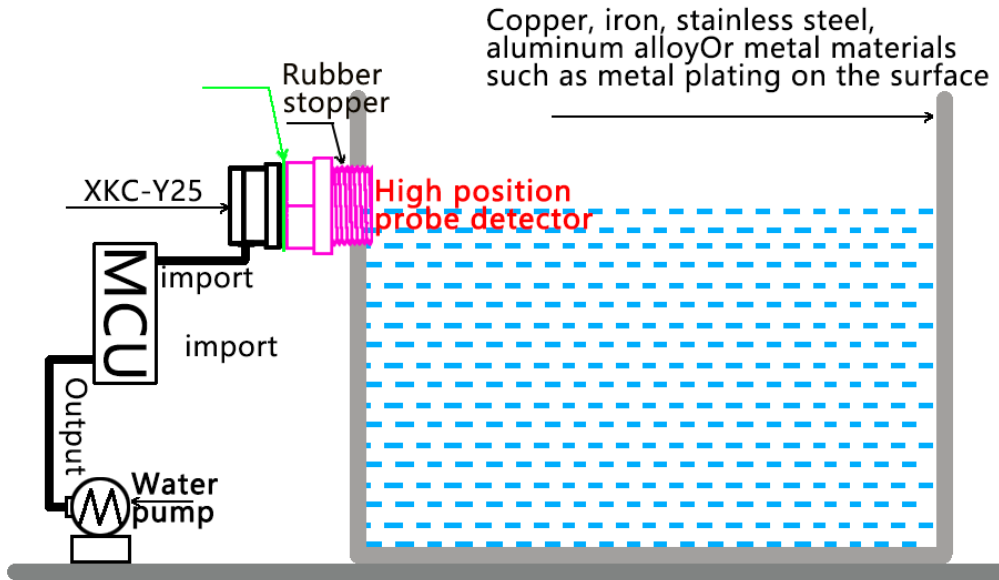

Figure 2-1 Installation diagram of a sensor in a metal container

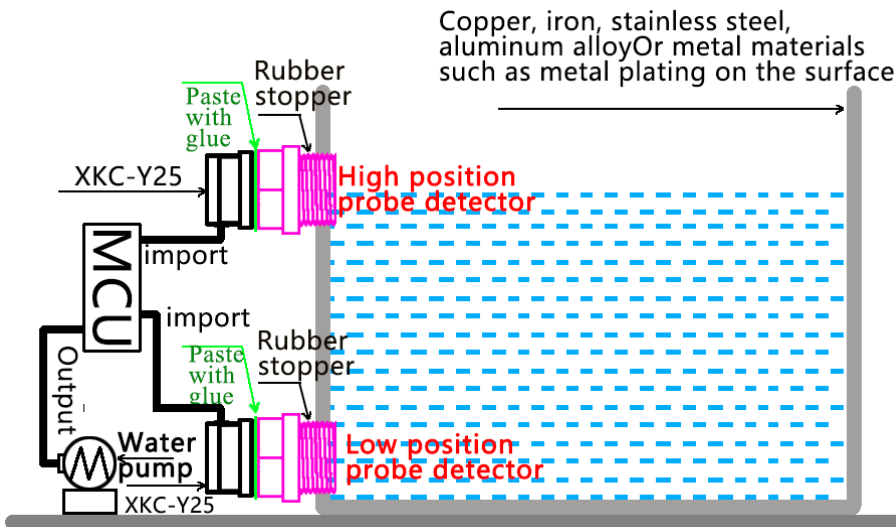

Figure 2-2 Schematic diagram of installation of 2 sensors in a metal container

The third category: non-metallic materials that absorb water

Containers made of ceramics, tiles, bricks, tiles, cement, wood boards and other materials are insulators or weakly conductive. This kind of container may not be detected when it is close to the liquid level sensor when it is dry and without water, but when the container is filled with water, the container wall will absorb water, causing the container wall to become a conductor; even if the container is empty When the sensor is close to the container wall, the signal will also be detected.

If the sensor is to be used on a container of this type of material, the installation method should be in accordance with the installation method of a metal container. For the installation method, see "Class 2: Metal Conductive Material Container" and Figure 2; or use an external pipe to install. External pipes are divided into external non-metallic pipes and external metal pipes

The installation method of external non-metallic pipes is shown in Figure 3-1 and Figure 3-2. The installation method of external metal pipes is shown in Figure 4-1 and Figure 4-2..

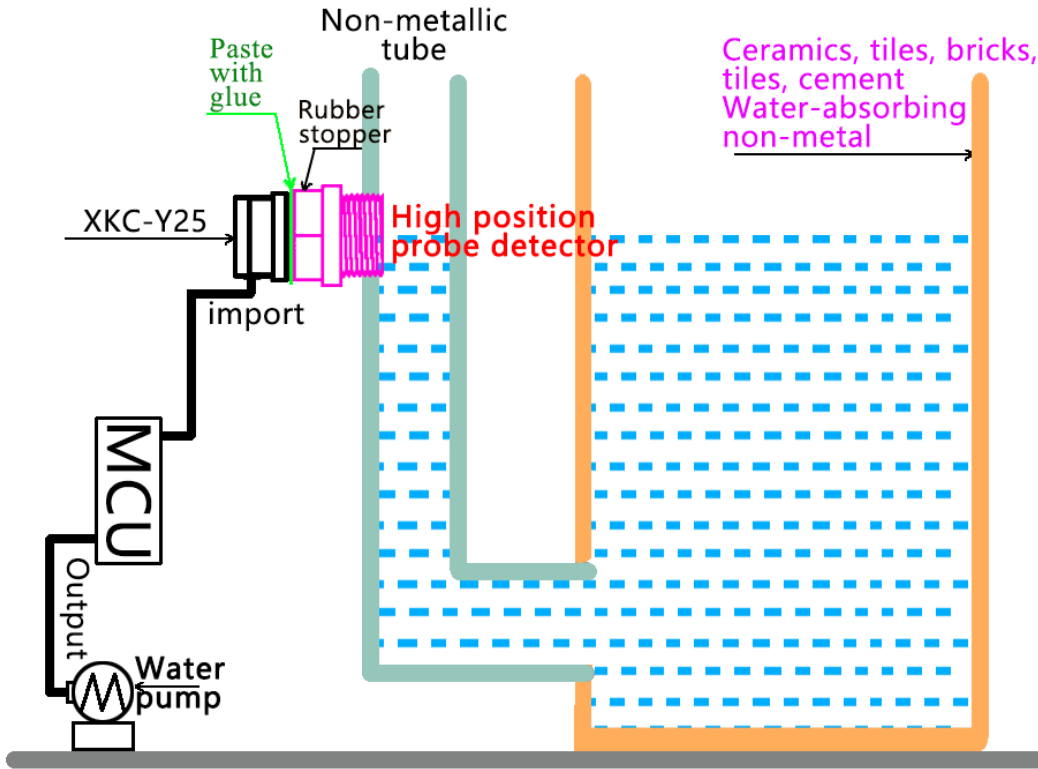

Figure 3-1 Schematic diagram of the installation of a sensor in an external non-metallic pipe

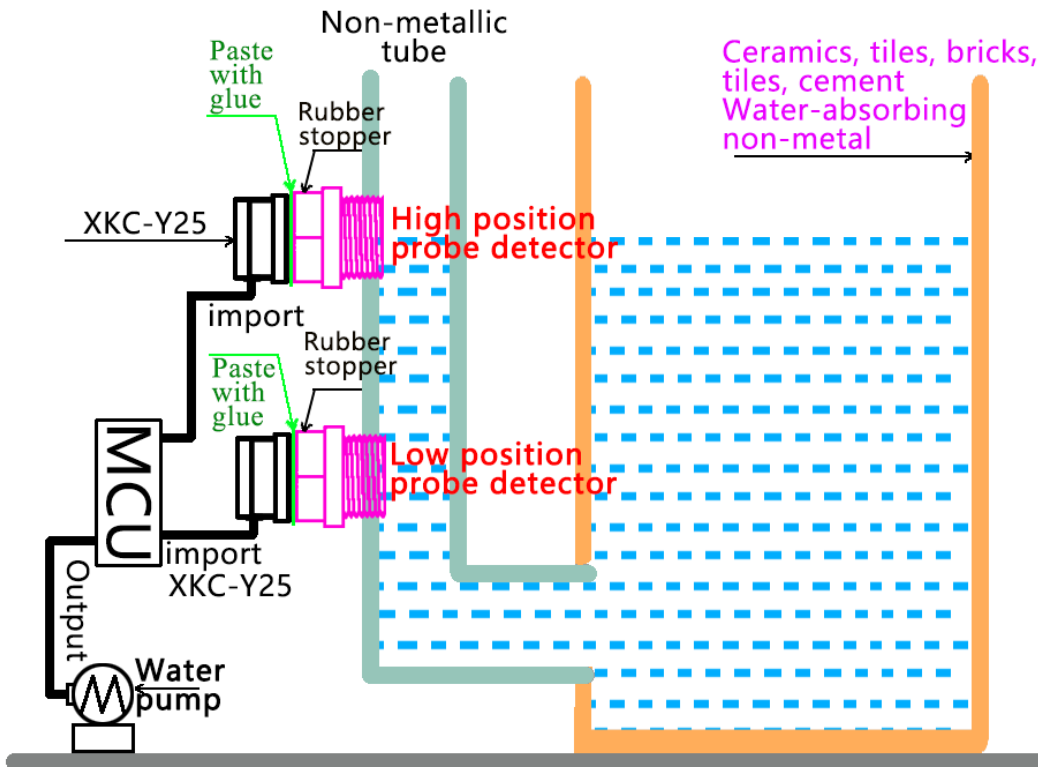

Figure 3-2 Schematic diagram of the installation of two sensors on external non-metallic pipes

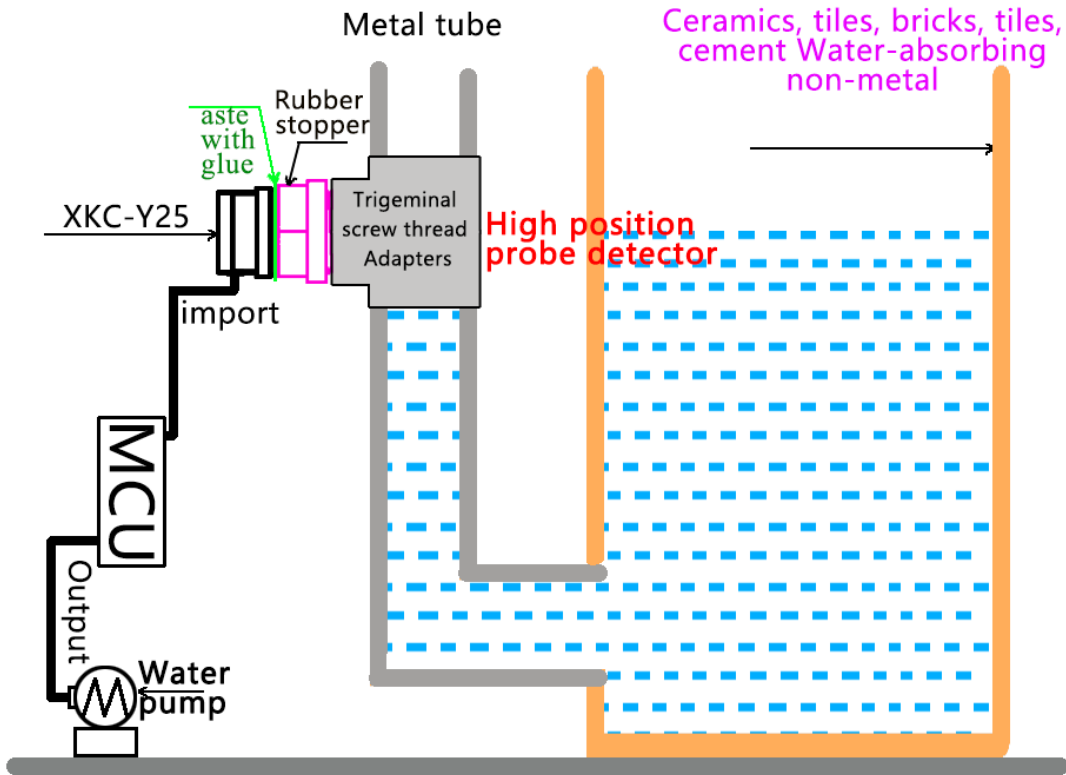

Figure 4-1 Schematic diagram of the installation of 1 sensor in an external metal pipe

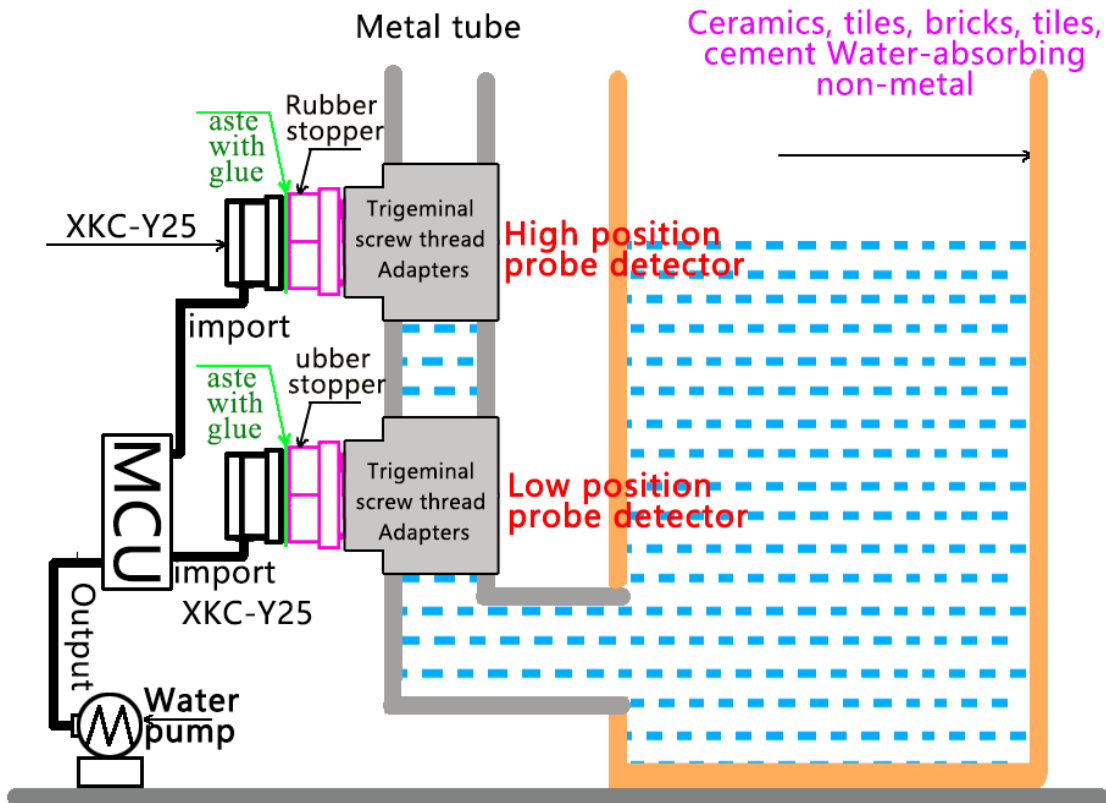

Figure 4-2 Schematic diagram of installation of two sensors on external metal pipes

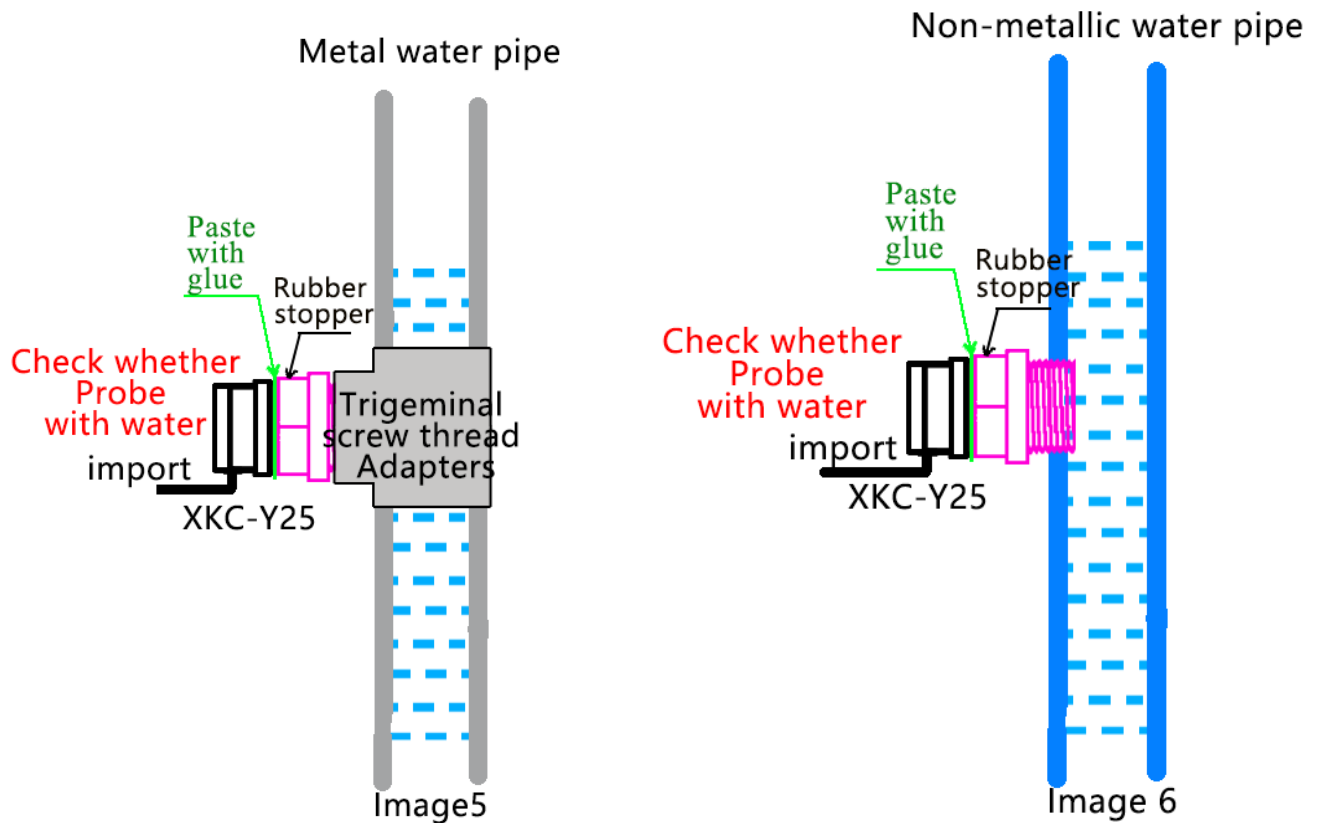

Figure 5 The sensor is installed on the iron pipe with the three-prong joint (the installation diagram of metal and water-absorbing container)

The sensor is installed on a non-metallic water pipe with a smaller diameter

8th. Application environment

1. XKC-Y25-V, XKC-Y25-NPN/PNP (5-12V)

It is only applicable under the conditions of good EMC environment. For example, the connection with MCU, and some simpler load applications, such as LED indicator lights, piezoelectric buzzer, etc. And there is no high-power capacitive and inductive load and harsh electromagnetic environment on the power bus.

2. XKC-Y25-NPN/PNP (24V), Y25-RS485 (24V)

This model is carefully designed for harsh industrial environments. Added professional EMC components, such as spike absorption, electromagnetic compatibility, and transient suppression and surge protection. It can be directly connected to PLC, electromagnetic relay, etc. It has a very strong anti-interference ability and is suitable for all harsh industrial application environments.

9th. output principle and recommended wiring method

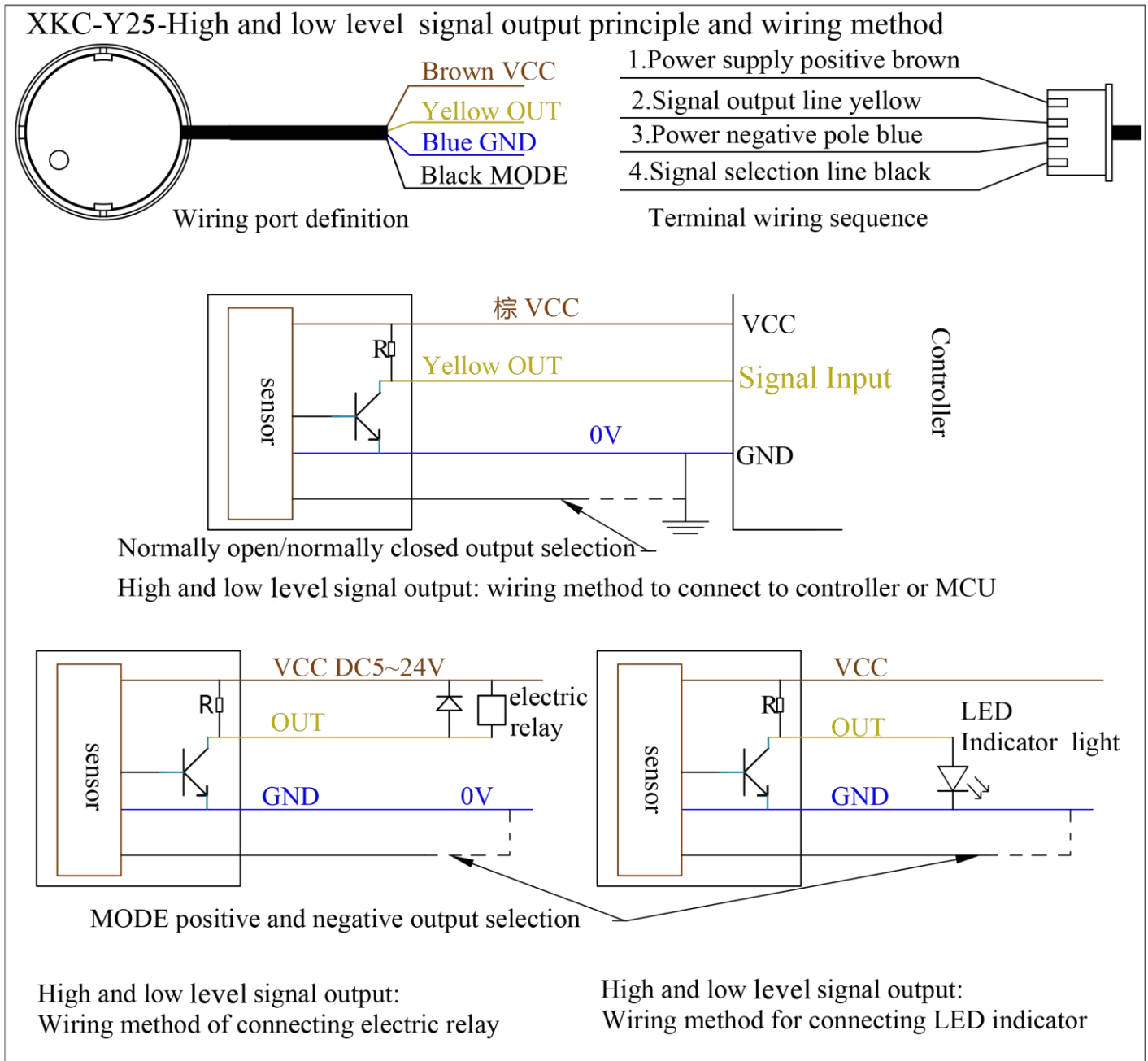

High and low level output drive small electric relay (coil current $\leq 100\text{mA}$) Product Applications:

1. When the black line is suspended, it is positive output:

When liquid is sensed, the transistor cuts off and outputs a high level, and the relay does not pull in when it is powered off;

When no liquid is sensed, the transistor turns on and outputs a low level, and the relay is energized and closed.

2. When the black wire is grounded (connected to the negative pole of the power supply 0V), it is a reverse output:

When liquid is sensed, the transistor turns on and outputs a low level, and the relay is energized and closed;

When no liquid is sensed, the transistor cuts off and outputs a high level, and the relay does not pull in when it is powered off.

10th. Sensitivity adjustment

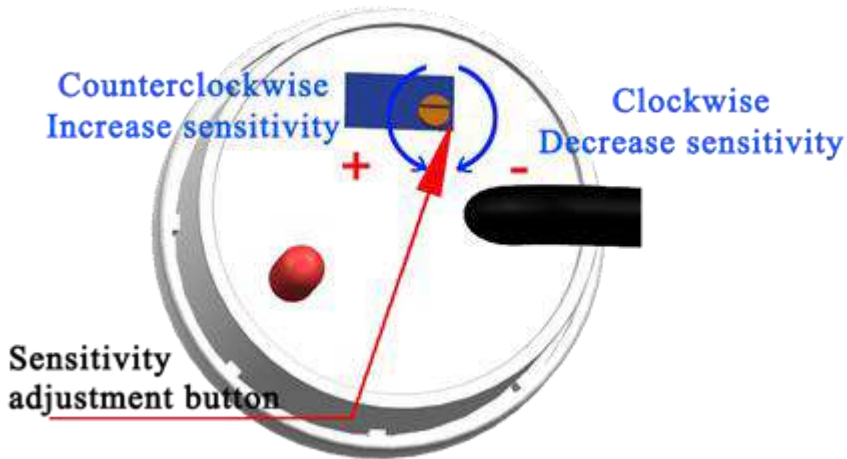

If the liquid level cannot be detected or the distance between the detected liquid level and the Y25 sensor is deviated, Open the back cover of the sensor and use a small screwdriver to adjust the sensitivity knob.

There are two setting methods:

1. Turn counterclockwise to increase sensitivity.
2. Turn clockwise to lower the sensitivity.

11th. Product size and physical map



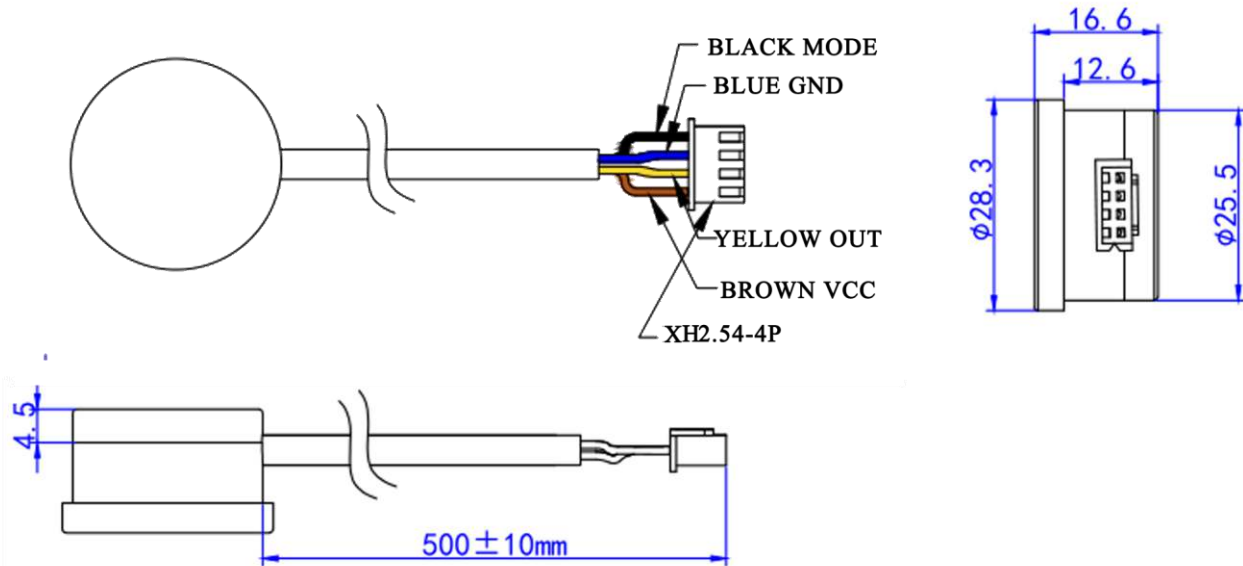

12th. Other matters needing attention

(1) The viscosity of the measured liquid medium

When the dynamic viscosity is less than 10mPaS, it is measured normally. 10mPaS < dynamic viscosity < 30mPaS may affect the detection. When the dynamic viscosity is greater than 30mPaS, it cannot be measured because a large amount of liquid adheres to the container wall.

(2) Note: As the temperature increases, the viscosity decreases, and most high-viscosity liquids are more affected by temperature. Therefore, pay attention to the influence of liquid temperature when measuring viscous liquids.

(3) Pay attention to keeping the level gauge clean, try to prevent corrosion and avoid violent collisions and blows from other objects.

(4) During outdoor installation, avoid direct sunlight and rainwater directly flowing to the main body of the level gauge, and keep away from high heat sources and pay attention to ventilation. If the ambient temperature exceeds the rated temperature, corresponding cooling protection measures should be taken.

(5) When the ambient temperature is lower than the normal operating temperature range of the level gauge, an instrument protection box or other protective rain cap devices can be used for antifreeze protection, and pay attention to keeping the level gauge dry. The sensor should be regularly maintained and inspected. (The detection time interval is determined by the use unit according to the specific situation)

13th. Troubleshooting:

Fault status	Analyze the reasons	Problem solving measures
After the liquid level sensor is energized, there is no response (the indicator light does not light when the water level reaches the sensing point, and the sensitivity adjustment has no response)	① The power cord is not connected	Check and connect the power
	② The positive and negative ends of the power cord are reversed	Correct wiring
	③ The power module is damaged	Replace the circuit board where the power module is located
	④ Sensitivity is too low	Adjust the sensitivity to the appropriate gear
The indicator light keeps on	① Sensitivity grade is too high	Adjust the sensitivity to the appropriate grade
	② The initialization parameters are	Return to the factory to reinitialize

	abnormally modified	
	③The sensor has debris or other metal parts close to it	Clean up debris and keep a certain distance from metal parts

14th.Product warranty terms and instructions

(A) .Warranty service

1. Warranty period maintenance: from the date of purchase, the product host has a one-year free warranty. The company has the right to decide to repair or replace the faulty part. If it is replaced, the replacement part may be a new device or a repair product of the same category, function, and quality. The replaced faulty part belongs to the company; the product Resale and repair do not affect the warranty period. Products that have been repaired or replaced continue to enjoy the original remaining warranty period service. If the warranty period is less than three months after the repair, the repaired or replaced part shall be shipped from the date of delivery Warranty for three months; all products of the company are guaranteed for repair.

2. Loss upon arrival (DOA) replacement: From the day of purchase, you can enjoy a free replacement service within 7 days. Products with the following problems are defined as DOA equipment: the packing and packing list do not match after the first unpacking of the product; some or all of the components cannot be used normally after the first unpacking of the product (surface scratches or other things that do not affect the function of the device) Defects are not included); other hardware failures identified by our company's engineers remotely or locally.

(B). Applicable limitations of warranty

For the following situations, the company does not assume warranty responsibility:

1. The product is out of warranty; the surface of the product is fragile and damaged; the appearance of the product is seriously damaged, installation/use in abnormal environment, unauthorized disassembly and repair/modification, external power supply damage and other abnormal damage;
2. Damage caused by incorrect installation and use of the product by the user not following the requirements of the manual;
3. Damage caused by natural disasters and human negligence (fire, lightning, flooding, impact, etc.).

(C) .Accessories and consumables are not covered by the warranty.

(D) .Non-free warranty service

Within two years of product purchase, for non-warranty product (including components) failures and damages, you can choose paid maintenance services (free labor costs), and we will charge the transportation cost of repairing parts and accessories according to the actual situation.

(E). Ways to obtain warranty service

It is recommended that you contact the dealer who purchased this product to obtain the warranty service. For the warranty, please present a valid warranty card (the dealer's stamp is required to take effect) or the purchase invoice/receipt: if you can't show it, the product's free warranty period 12 months from the product shipment date, and the latest DOA application deadline is 7 days from the product shipment date.

(F). Statement

1. The copyright of this manual belongs to Shenzhen Xingkechuang Technology Co., Ltd. (Xingkechuang) and its authorized licensors. Shenzhen Xingkechuang Technology Co., Ltd. (Xingkechuang) reserves all rights.

2. Without the written permission of the company, no unit or individual may excerpt or copy part or all of the contents of this manual, and shall not spread it in any form.

3. The customer recognizes that the purpose of the design and production of the company's products does not involve use in products related to life support or other systems or products used in other dangerous activities or environments. Personal injury or death, property or environmental damage due to product failure (collectively referred to as high-risk activities). The company's products are artificially used in high-risk activities, and the company does not guarantee it and is not liable to customers or third parties.

4. Due to product version upgrades or other reasons, the contents of this manual may change. Xingkechuang reserves the right to modify the contents of this manual without any notice or prompt. This manual is only used as a guide. Xingkechuang makes every effort to provide accurate information in this manual. However, Xingkechuang does not guarantee that the contents of the manual are completely free of errors. All statements, information and suggestions in this manual do not constitute any express or Implied guarantee.

5. Not all models are available in all countries/regions

Please keep this manual properly. Before using the product, please read this manual carefully. When using the product, please be sure to operate in accordance with this manual. The company is not responsible for injuries and accidents caused by operations that do not follow this manual.

(G).Environmental protection This product meets the design requirements for environmental protection.The storage, use and disposal should comply with relevant national laws and regulations.Seek to proceed.

15th. Manual version

Version	Release date
V16	September 28, 2020